



With the help of an adult, read from the Scriptures
Joshua (Yehosua) 3:1-8

Circle the correct Word.

1. Joshua and all the people departed to:
SHITTIM - JERICHO - EGYPT.
2. The Israelites were to pass by the river:
NILE - JORDAN - EUPHRATES
3. Israel's officers toured the camp after:
15 DAYS - 3 DAYS
4. The people were to march behind:
THE OFFICERS - THE ARK - JOSHUA
5. Joshua commanded the people to:
SANCTIFY THEMSELVES - TAKE A BATH - EAT
6. The Ark of the Covenant was to be taken by the:
OFFICERS - ELDERS - PRIESTS
7. Yahweh said that from that day He would begin to magnify:
CALEB - JOSHUA - KORAH



Israel had to follow the priests to cross the Jordan River, help them find the right way to get to the other side.

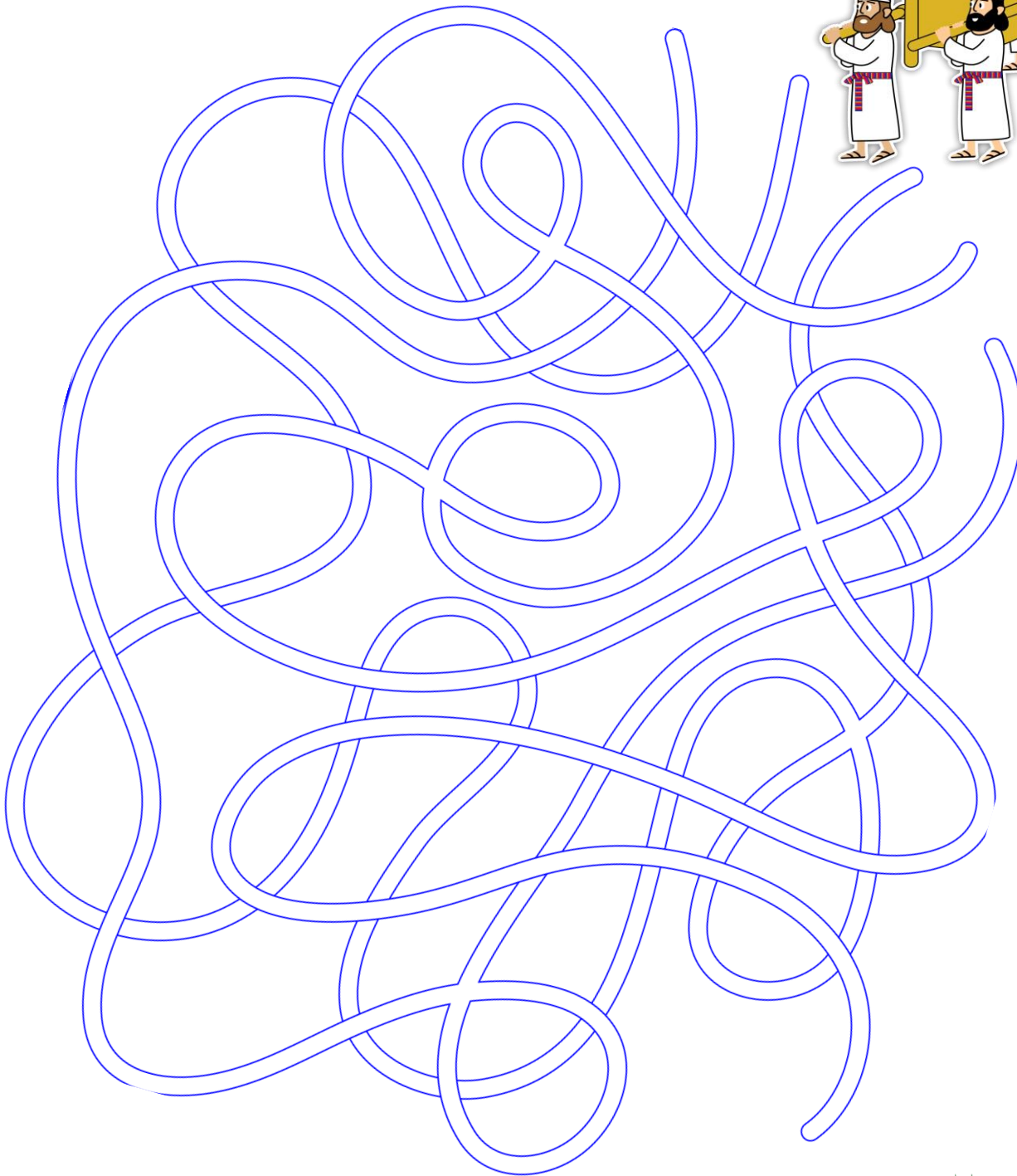
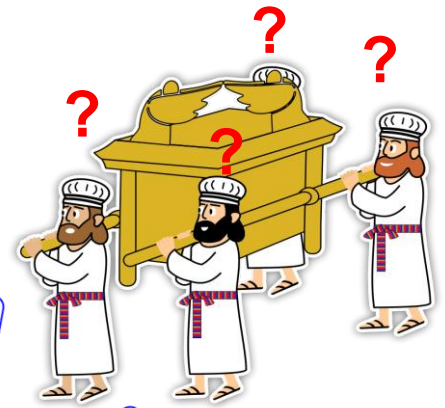



Write above each picture the initial letter.

Complete the following sentence with the word you find.

In verse 5, Joshua commanded the people to sanctify themselves because Yahweh was about to make _____

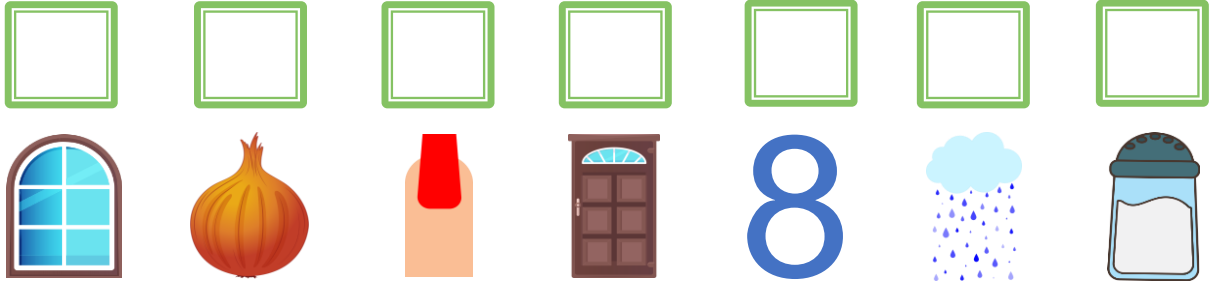

Think about this:

What wonders has Yahweh done for you and your family? _____

Connect the dots and color the Ark of the Covenant, remember that it was made of gold.

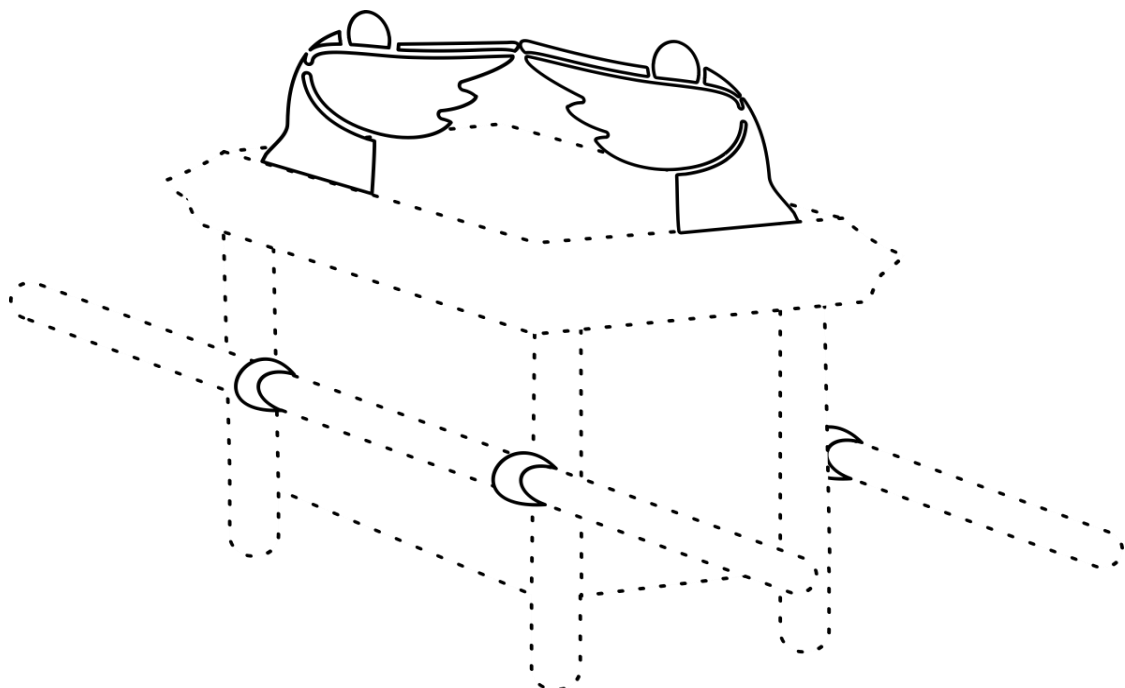

With the help of an adult, read from the Scriptures
Joshua (Yehosua) 3:9-17



Color the box with the letter T if the sentence is correct or
the box with the letter F if it is false.

Yahweh led Israel through Caleb.

T

F

The people crossed the river in small boats.

T

F

Yahweh stopped the waters of the Jordan.

T

F

The priests were in the midst of the river as Israel passed by.

T

F

Israel obeyed Joshua.

T

F

The waters of the river parted as the priests carrying the Ark of the Covenant
dipped their feet. Yes _____ No _____



LET'S MEMORIZE

“And Joshua said unto the people, Sanctify yourselves: for
tomorrow Yahweh will do wonders among you.”

Joshua (Yehosua) 3:5



Color the correct amount.

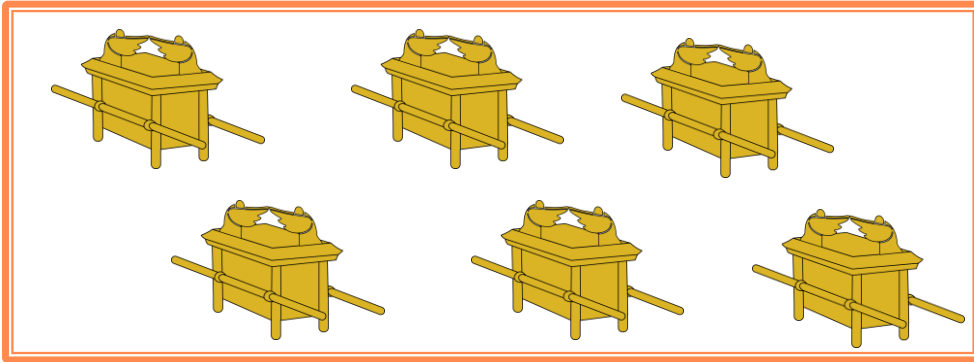

3

5

6

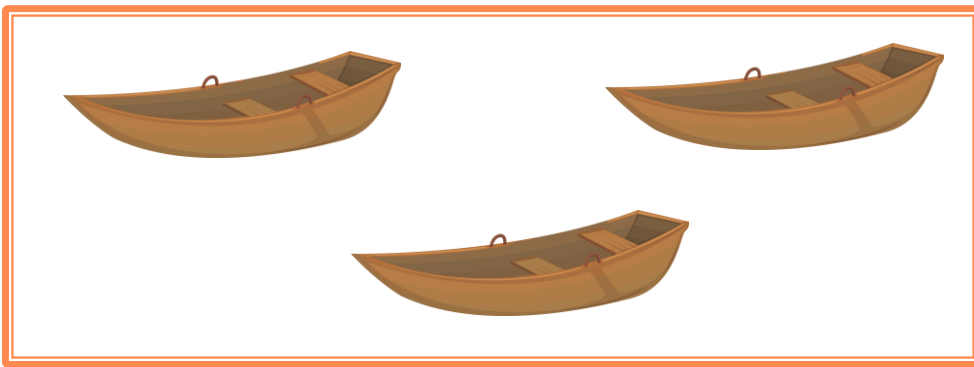

3

2

4

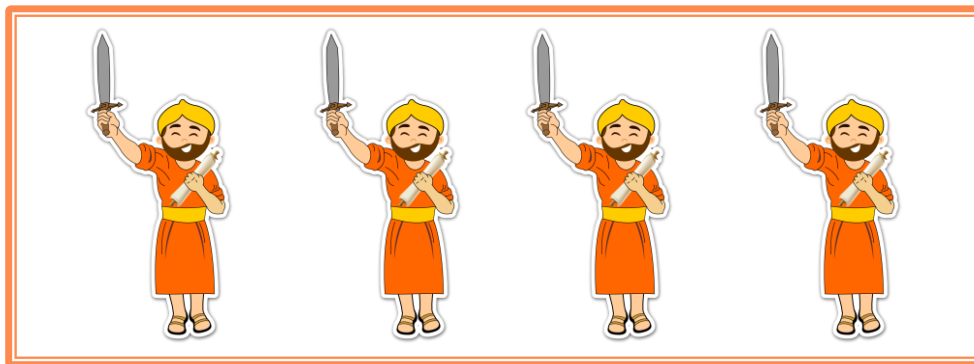

6

4

3

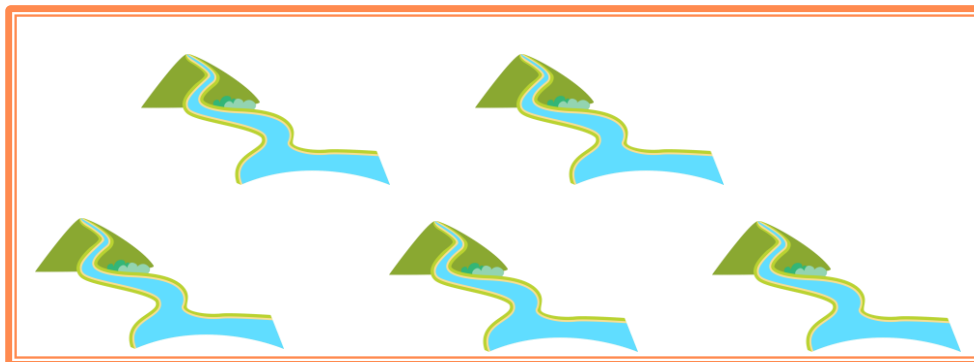

2

1

5